

Czech ⊕ Slovak Hackerspaces

rmarko || stick || wao

Czech⊕Slovak Hackerspaces

- **Brmlab (Prague)**
- **Silicon Hill MacGyver (Prague)**
- **Base48 (Brno)**
- **PiSeC (Pisek)**
- **Progressbar (Bratislava)**
- **V01D (Košice)**
- **Žilina (coming soon)**

Hackerspaces

What are they? How do they even work?



A hippie place

**Where you can do
whatever you want.
Unless you harm or kill others.**



Seriously.

Space.
Equipment.
Knowledge Sharing.

Open to Everyone!*

Open Platform for Everyone!

brmlab

hackerspace Prague



brmlab
hackerspace prague

soc-room



hw-lab



brmdoor



ledbar

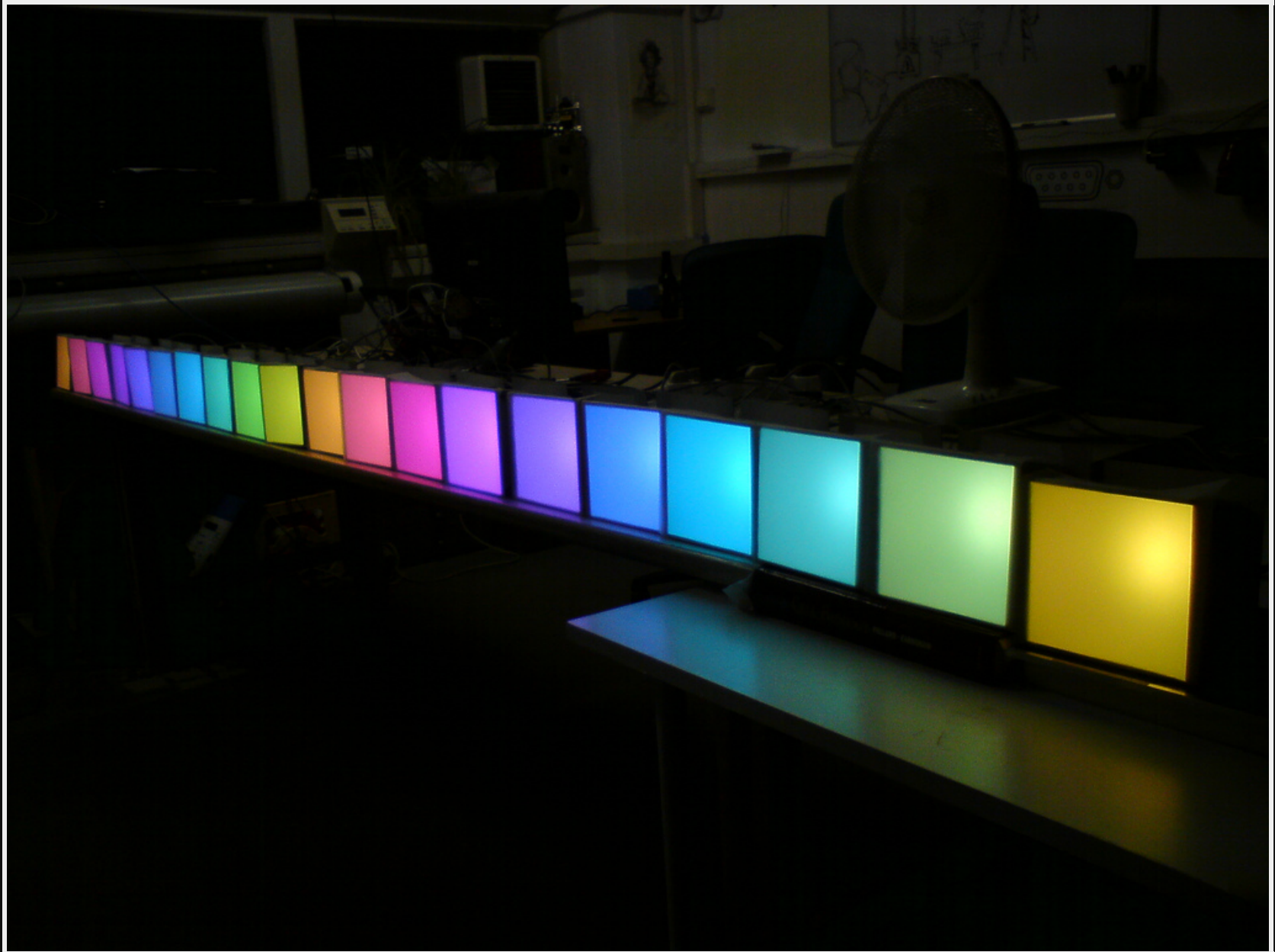

sandbox

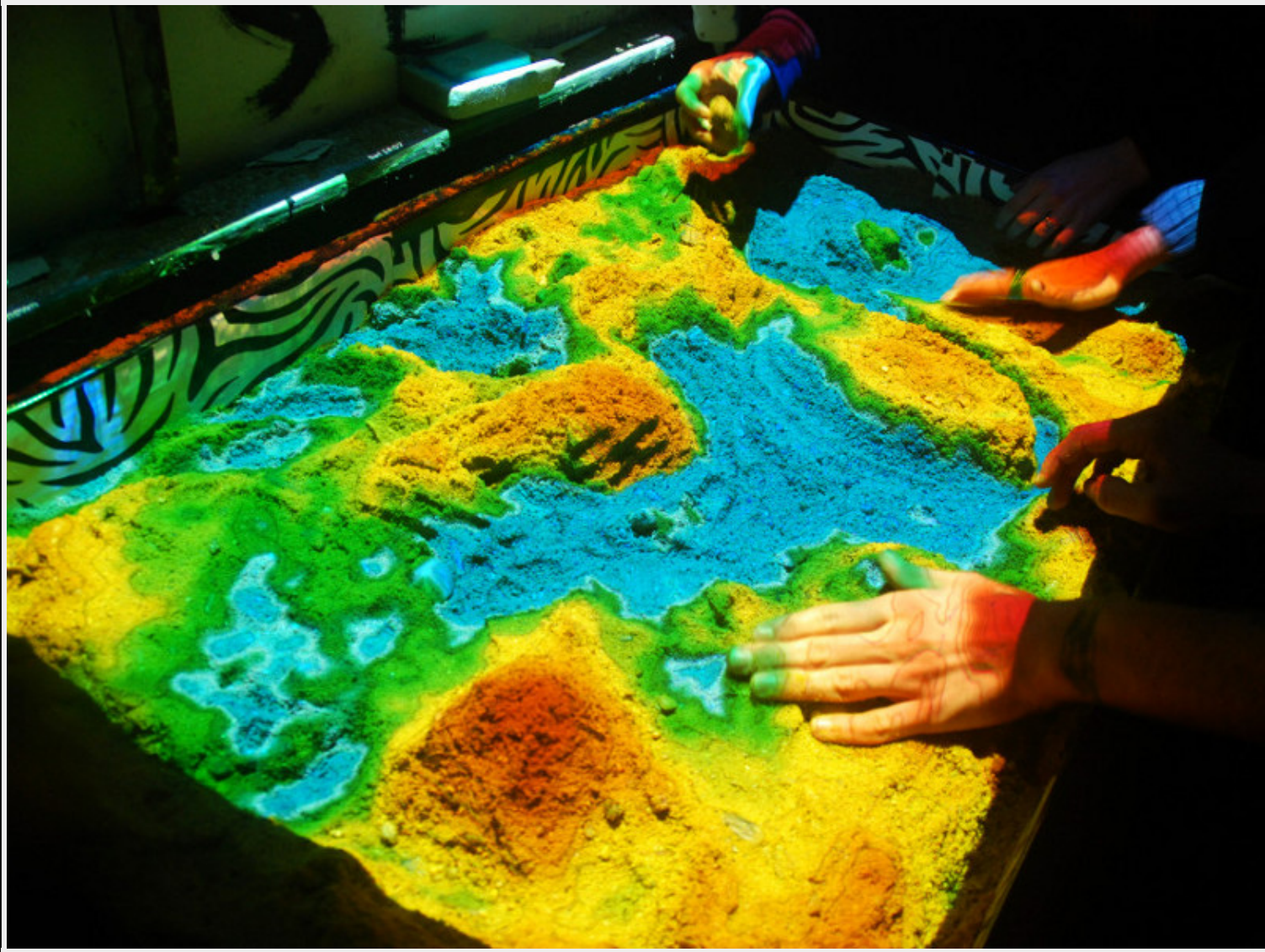

gsm hacking



lockpicking



sdr

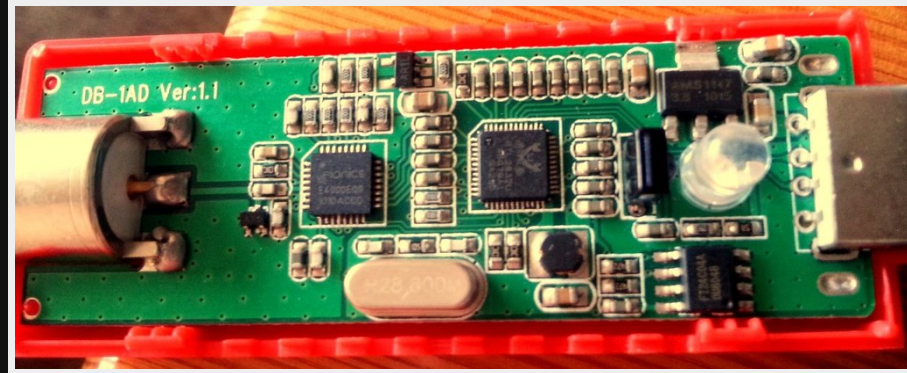

File Data View Help

91.400 000 MHz -100 -80 -60 -40 -20 0
-14 dBFS

Receiver Options X

500.000 KHz

Receive: 91.900000 MHz

Filter: Wide

Mode: FM

AGC: Medium H

NB1: 3.3 NB2: 2.5

SQL

Mode options

Max dev: BC (75k)

Tau: 1 ms

OsmoSDR Con... Receiver Opt...

Audio X

Gain: 19 dB

Audio FFT Settings

laser

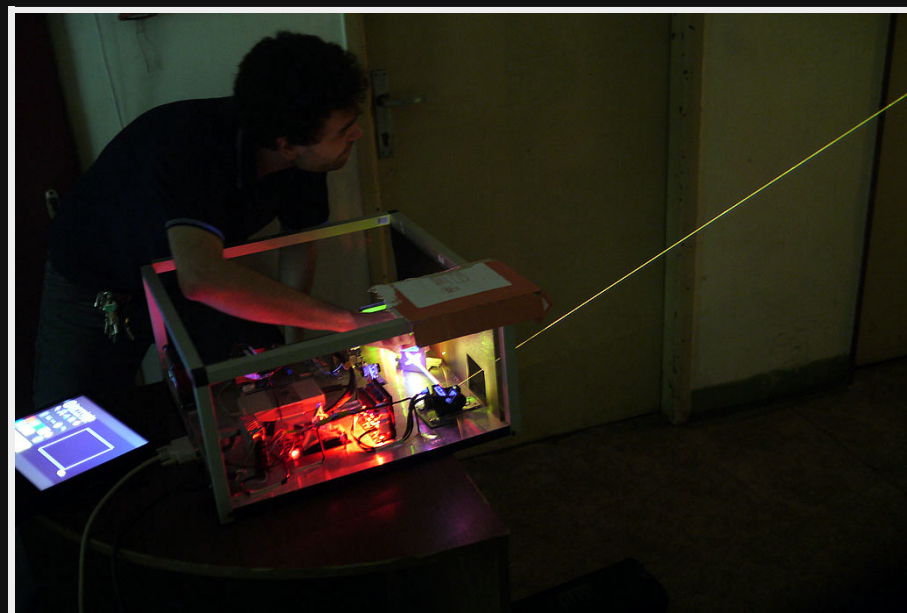



skinner box

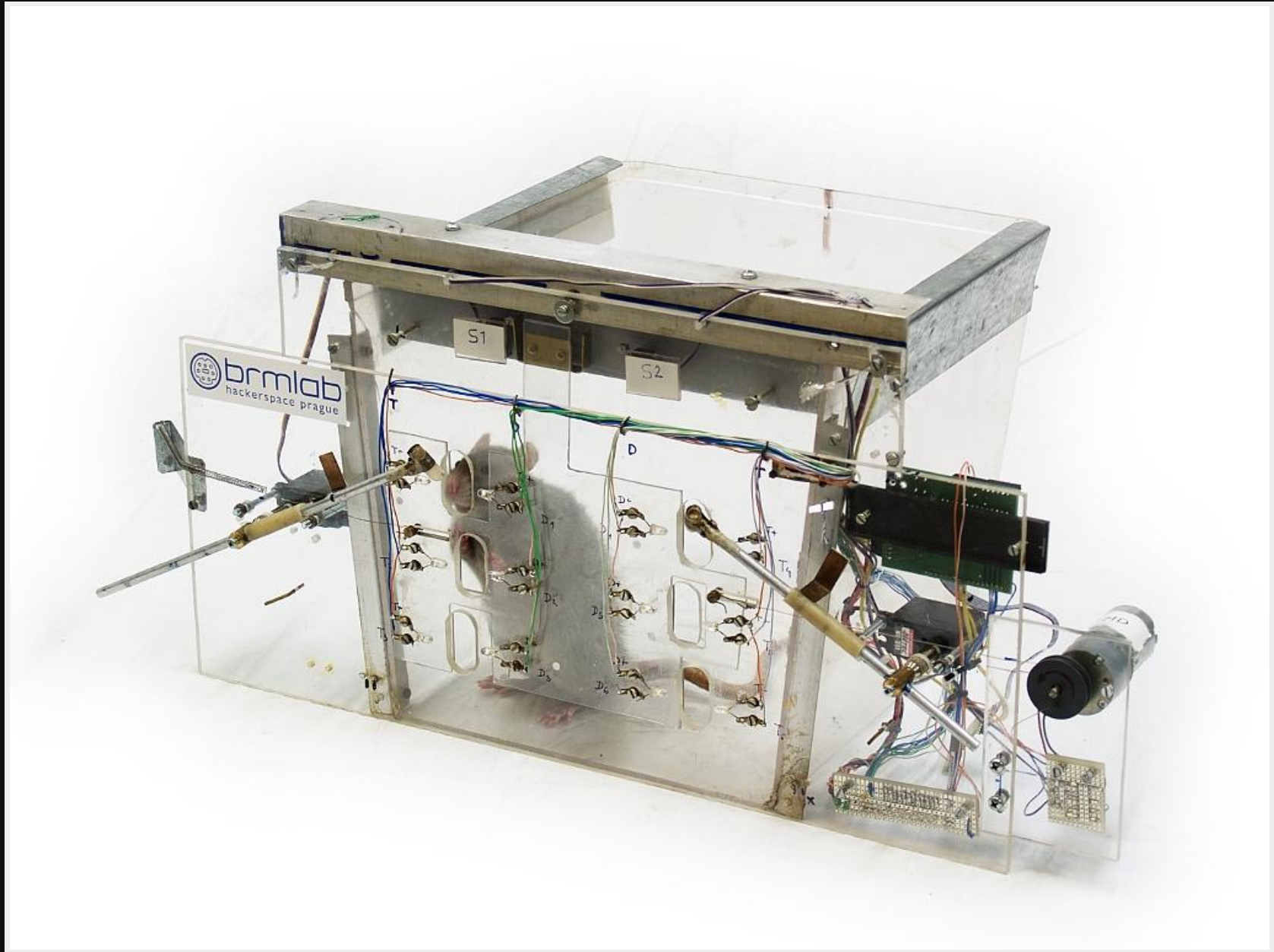

rtg



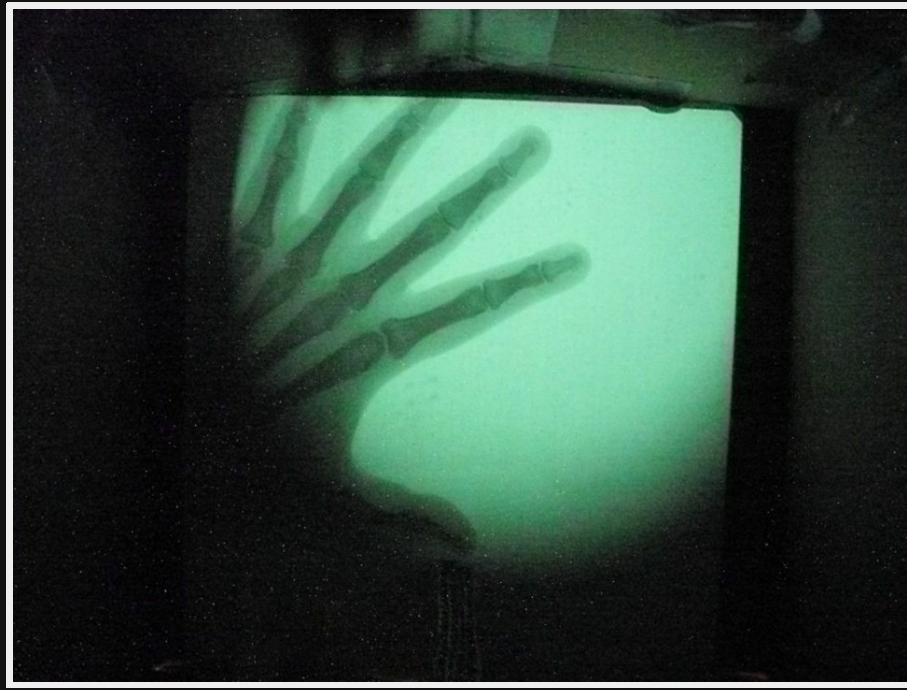

tesla coil

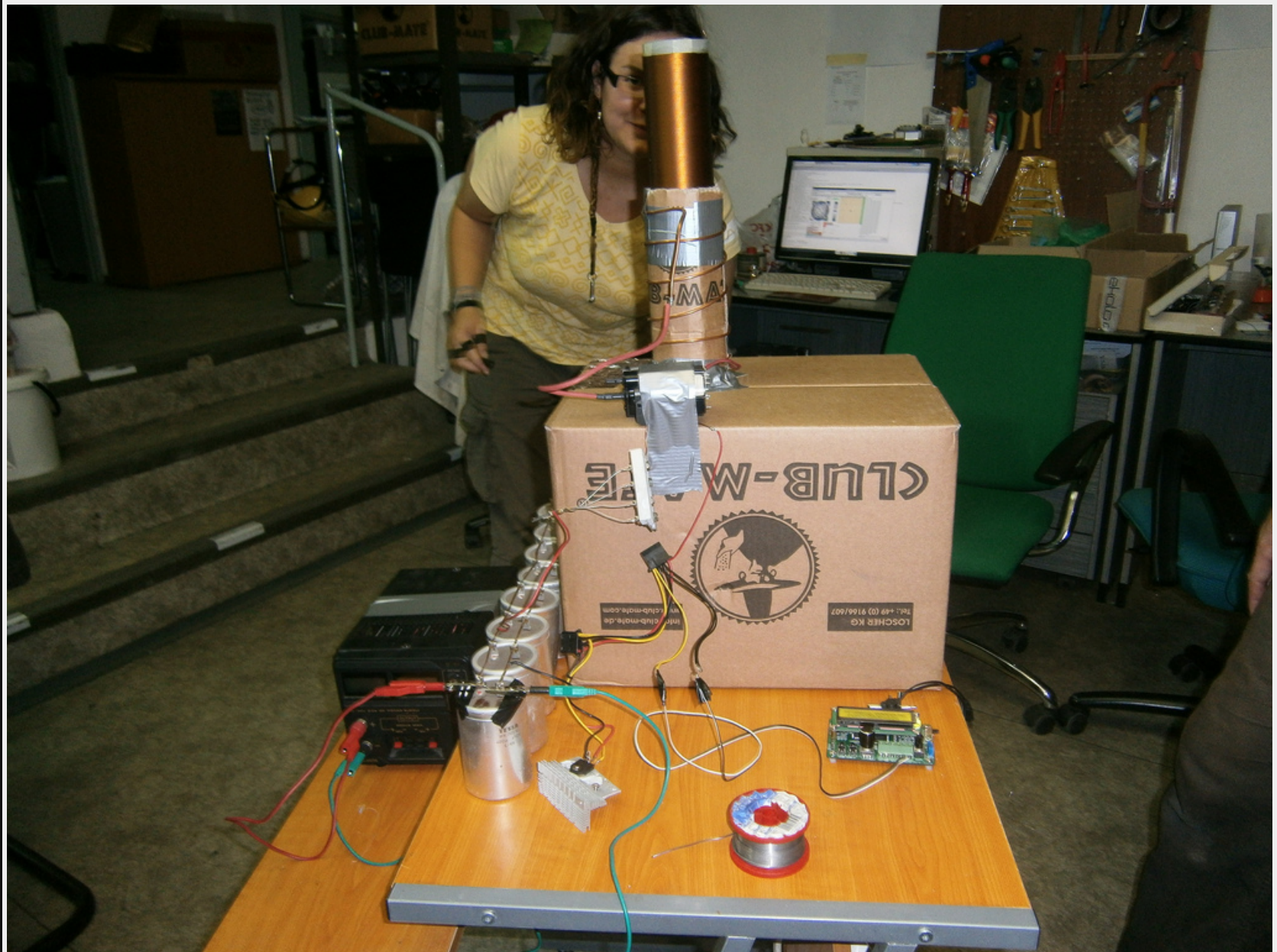

bitcoin



base48

hackerspace Brno

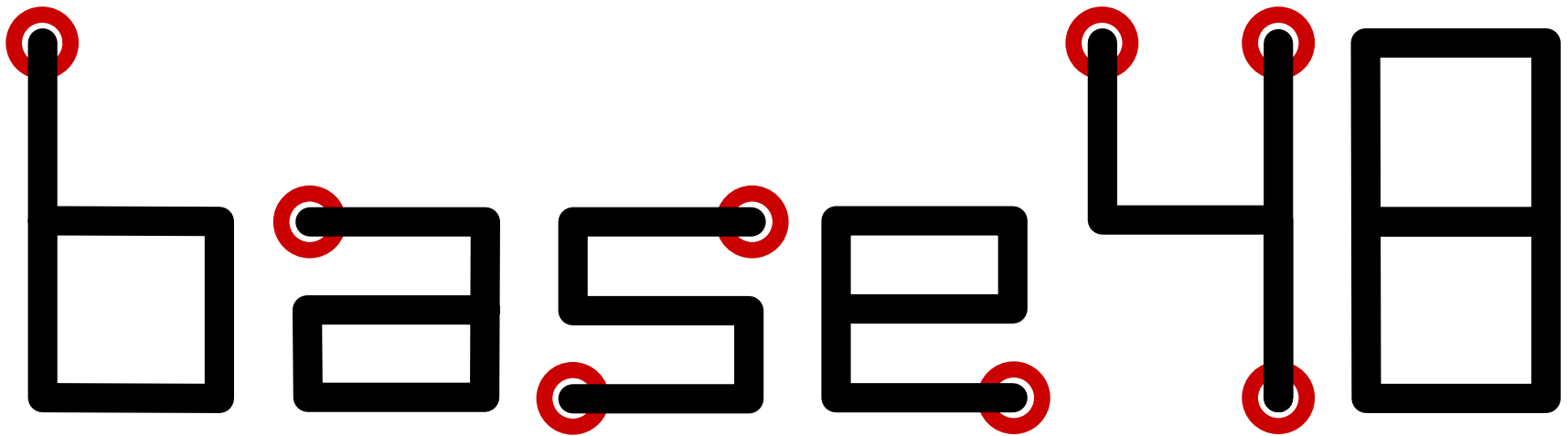

space



Microcontrollers

- AVR/Arduino
- MSP430

ARM microprocessors

- M3/M4 development boards
- Raspberry Pi
- Cubieboard
- ARM RTOS

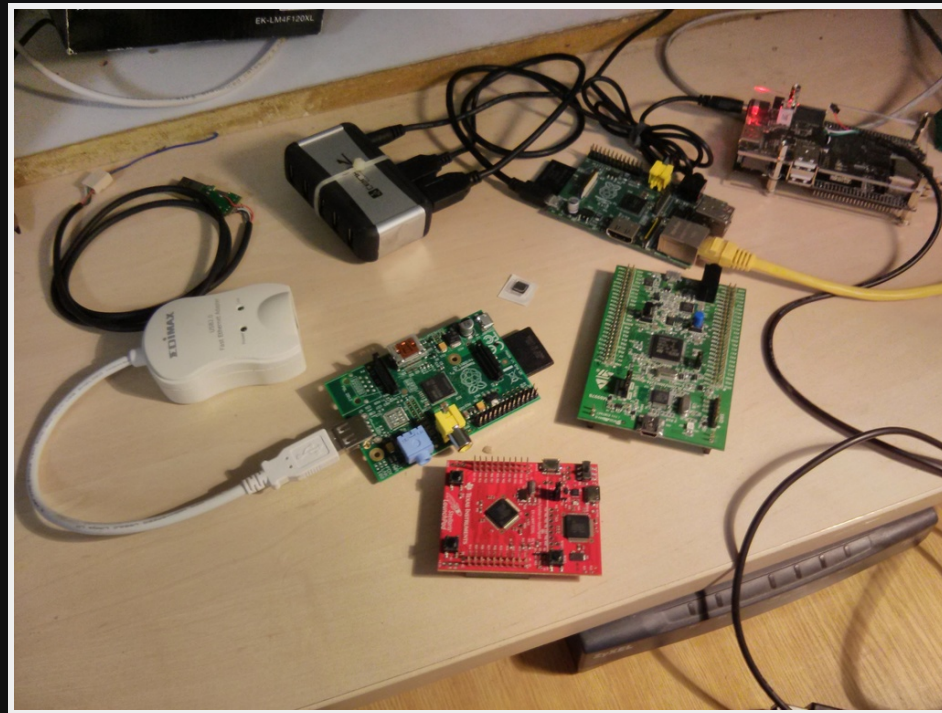

3D Printers

Reprap

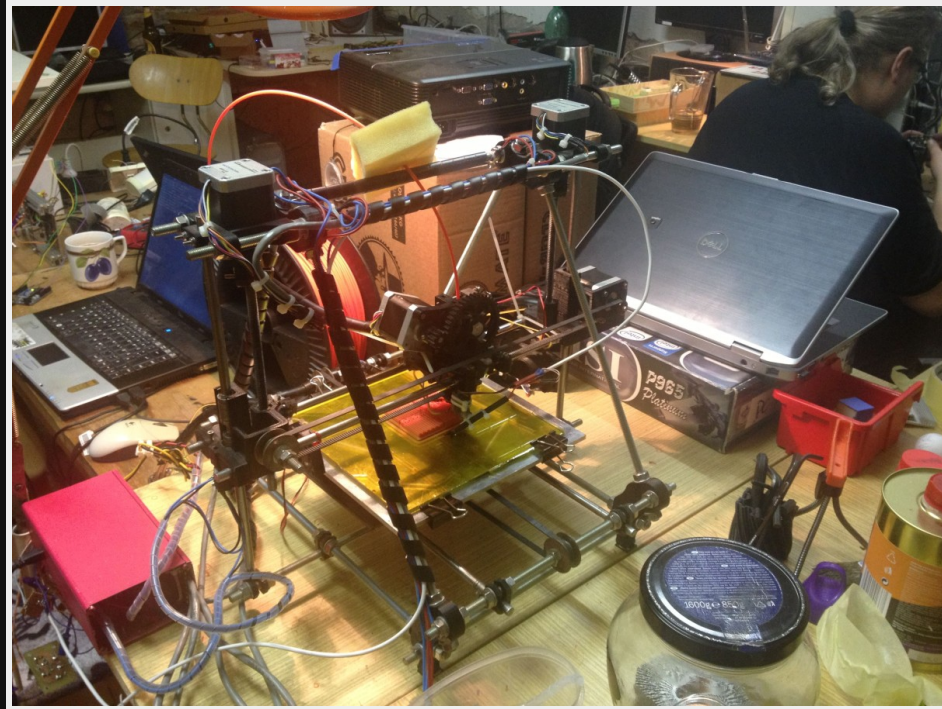

3D Printers

Rostock

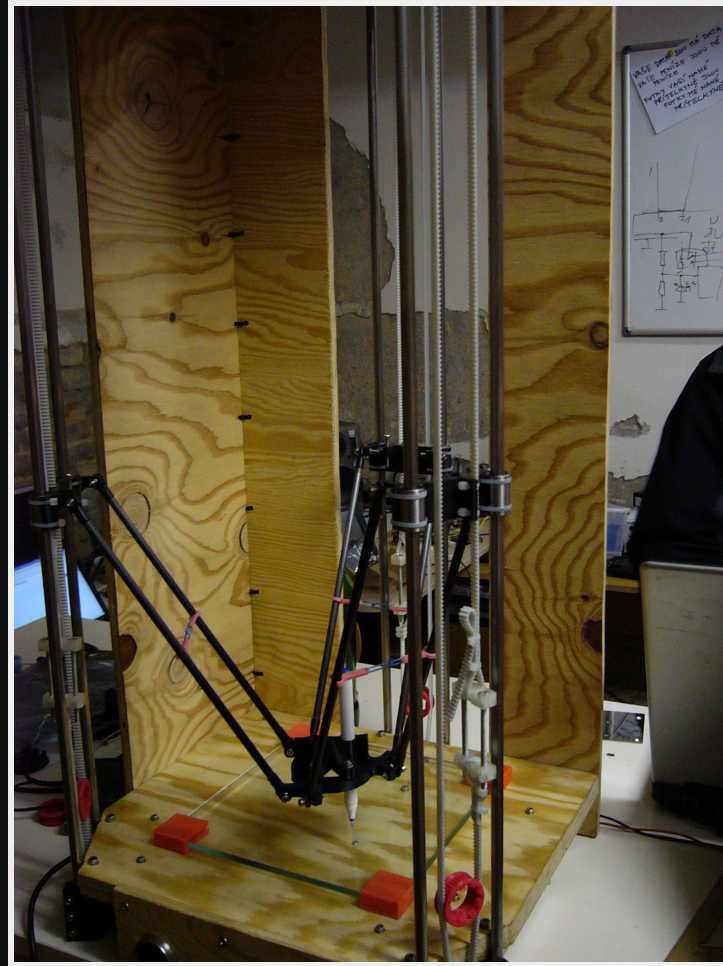

Spherebot

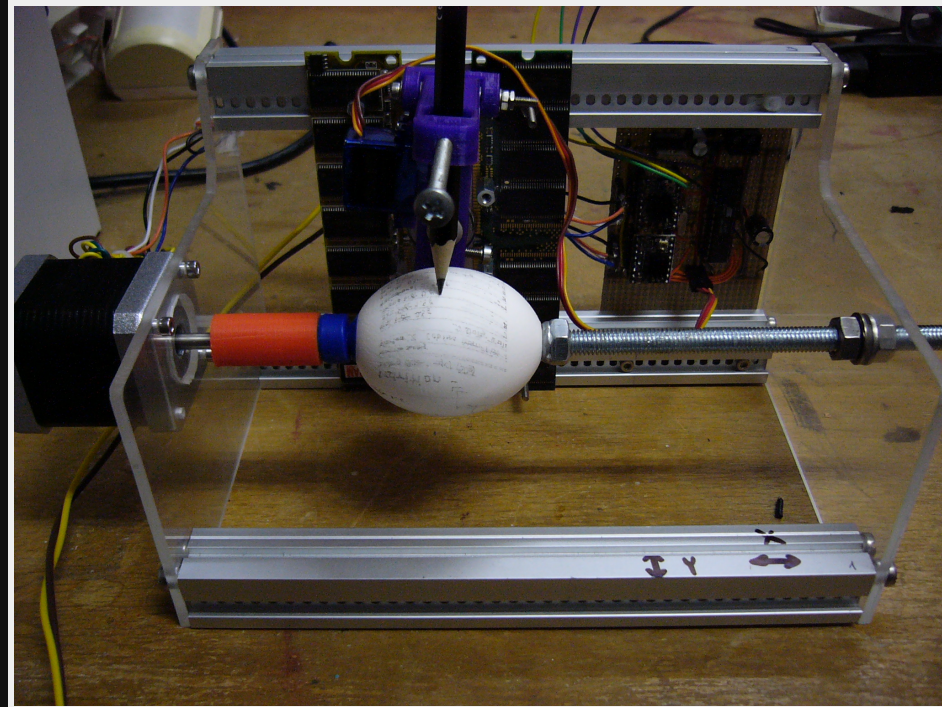

ART!



ART?

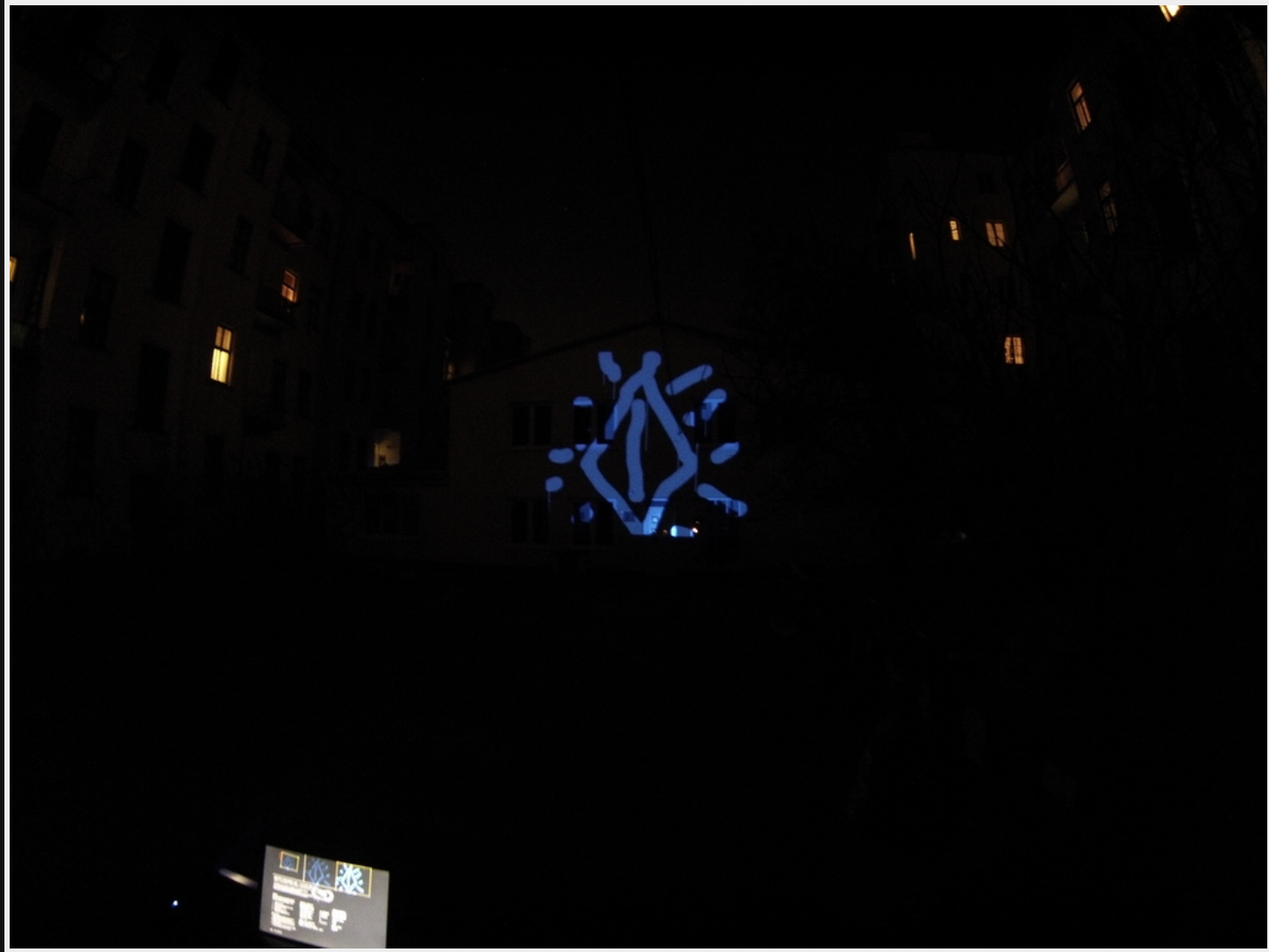

DIY Vaporizer

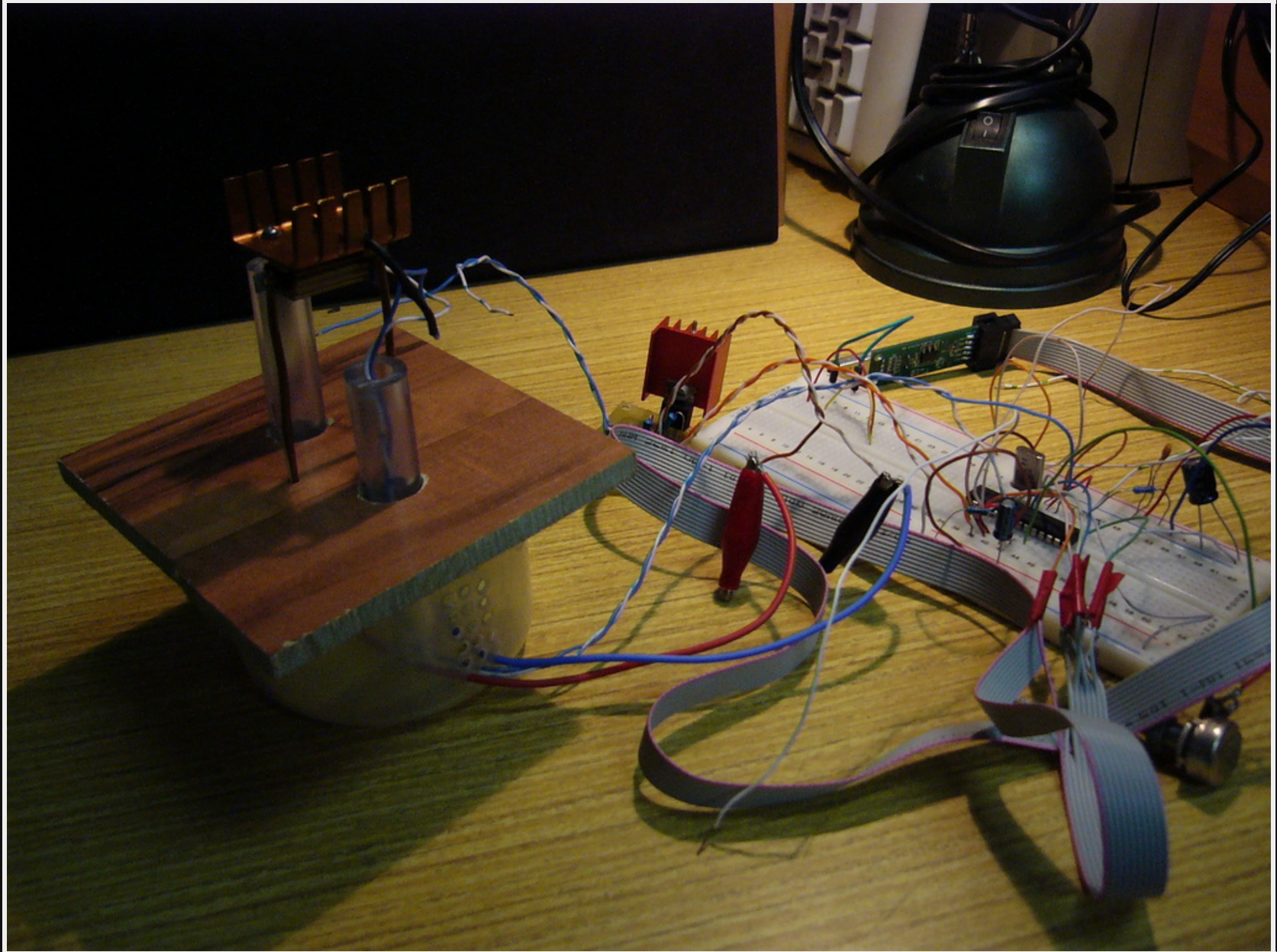

Esoteric stuff

- Plan9
- Haiku
- Minix



Cyklo Dílna

Every Wednesday @6pm



Workshops

- wifi security
- upcoming:
 - TV-B-Gone
 - 3D Printing
 - OpenSCAD CSG modeling

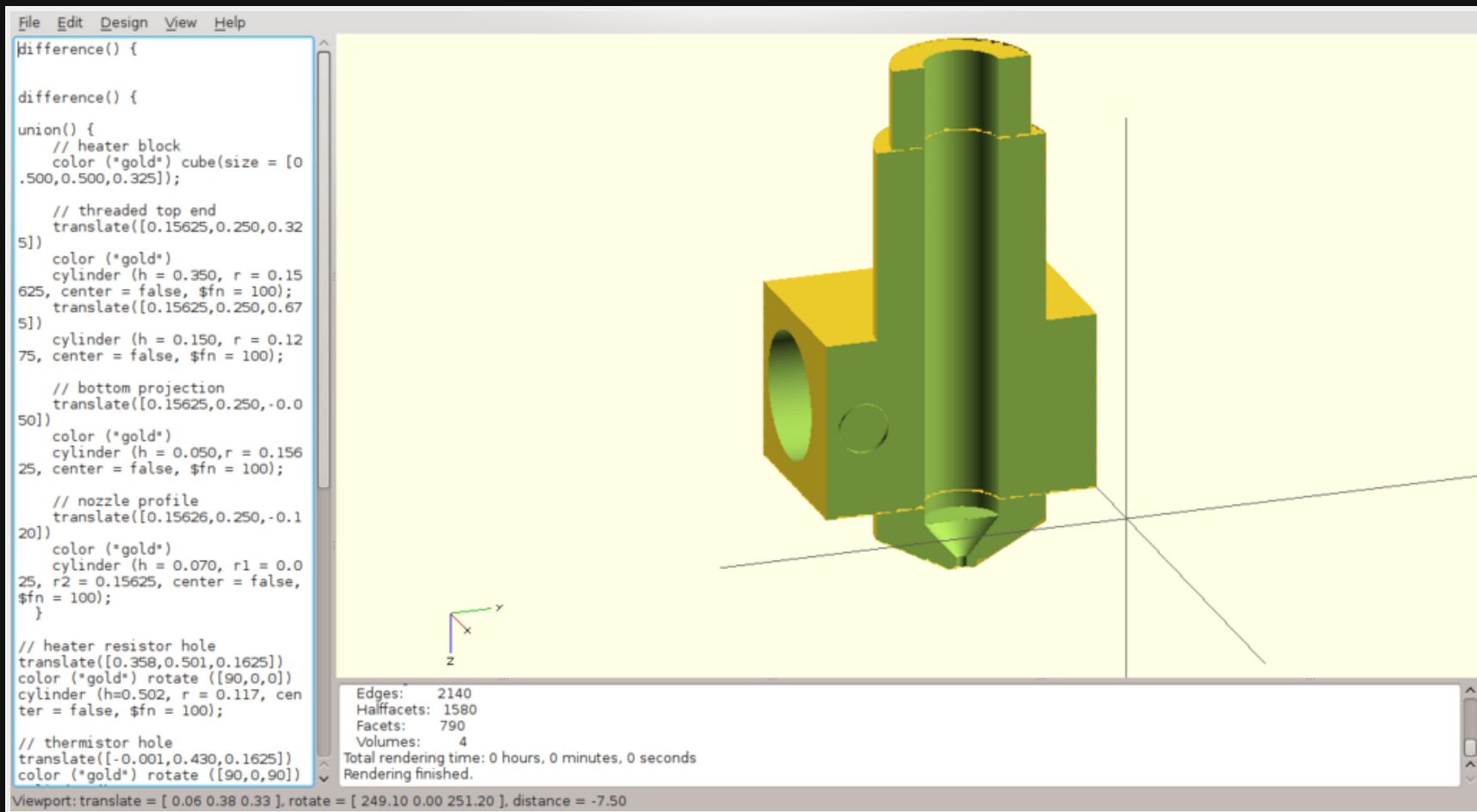

Security?



#base48 on freenode

```
-( Today Open from 15:37 < hell o world > RRap route planning - http://xkcd.com/1185/ | #define NULL (::rand() % 2)
[01:18:00] < AAAAAAAAAA> -----
[01:18:00] < AAAAAAAAAA> < AAAAAAAAAAaaaaAAAAAAAAA AAAAAAAAAA AAAAAAAAAA aaAAAAAAAAAA WAO WOHO00 >
[01:18:01] < AAAAAAAAAA> -----
[01:18:03] < AAAAAAAAAA>
[01:18:05] < AAAAAAAAAA>
[01:18:07] < AAAAAAAAAA>
[01:18:09] < AAAAAAAAAA>
[01:18:11] < AAAAAAAAAA>
[01:58:38] < stick`> kokoz
[01:58:39] < stick`> wam to jebe
[01:58:43] < stick`> *
[01:58:45] < stick`> aaaaAAAAAAAAA AAAAAAAAAA
[01:58:54] < aaaaAAAAAAAA> robte radsej slajdy na konfery
[01:58:54] < stick`> co sme wao?
[01:58:54] < stick`> teraz som kukal a ziaden commity
[01:58:55] < stick`> :)
[01:58:55] < stick`> *
[01:58:57] < gh> AAAAAAAAAA
[01:58:57] < gh> blbot sorki pushed 3 new commits to master: http://git.io/0Fca1A
[01:58:57] < gh> blbot/master 5c0223f Martin Milata: HackerSpace Status API...
[01:58:57] < gh> blbot/master 0a22473 Martin Milata: spaceapi: listen on both ipv4 and ipv6
[01:58:57] < gh> blbot/master 83e8d00 Richard Marko: Merge pull request #1 from mmilata/master...
[01:59:01] < aaaaAAAAAAAA> jak ziadny commit
[01:59:14] < stick`> :D
[01:59:18] < stick`> tak to bolo super
[01:59:21] < AAAAAAAAAA> :D
[01:59:45] < AAAAAAAAAA> -----
[01:59:45] < AAAAAAAAAA> < stick`, SI NACASOVAL! :D >
[01:59:45] < AAAAAAAAAA> -----
[01:59:45] < AAAAAAAAAA>
[01:59:45] < AAAAAAAAAA>
[01:59:45] < AAAAAAAAAA>
[01:59:47] < AAAAAAAAAA>
[01:59:50] < AAAAAAAAAA>
[01:59:53] < AAAAAAAAAA> \o/
```

Progressbar

hackerspace Bratislava



LedBar

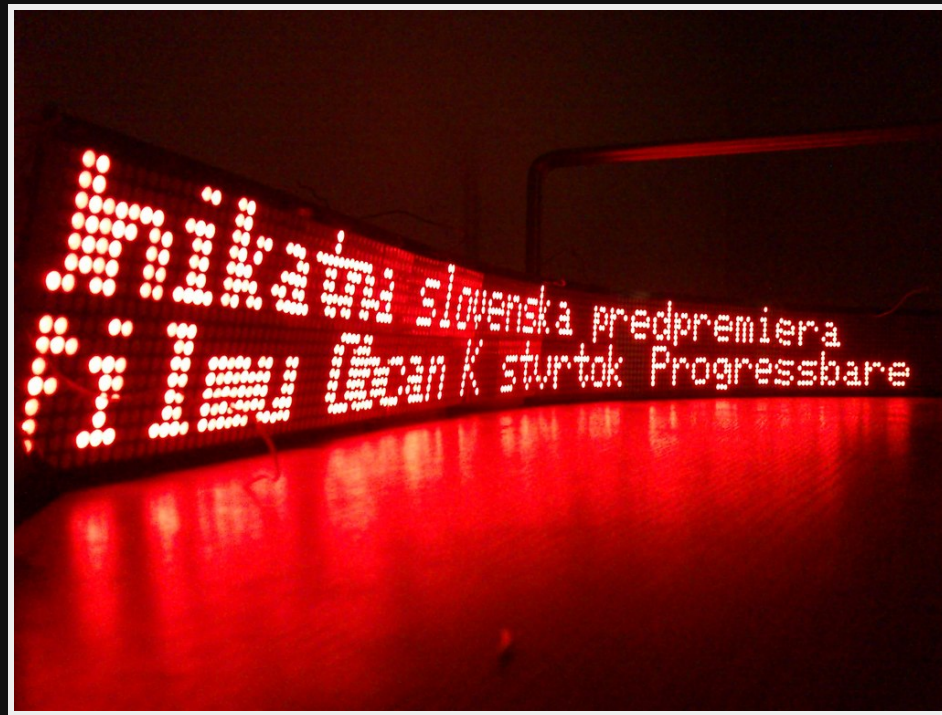

- arduino
- arduino ethernet
- 9pcs led matrix

RGB Led wall



- arduino
- some shift registers
- bunch of rgb leds

Bitcoin groups



- critical usage of Bitcoin
- spreading usage in local town
- using forks of another cryptocurrencies

Purpose



- tax evade?
- buying drugs?
- get rich fast?
- you decide!

BUY!!!!



We also have 3D printer(s)



- limited by your skill in 3D modeling
- limited by 45 angle "law"
- otherwise unlimited

4 worst things people print

#1 Dildos



#2 Firearms



#3 Fetus



#4 Bongos

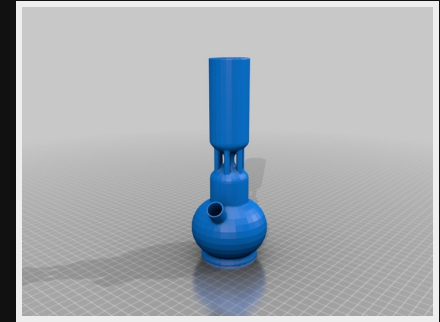

Workgroups

**we try to provide space for
volunter-based communities**

Freemap.sk

Doing better maps for openstreetmap.org
, specifically Slovakia!



Installfest

Helping people with Linux, HTPC, basic networking, games on Linux, Retro folks, Sysadmins

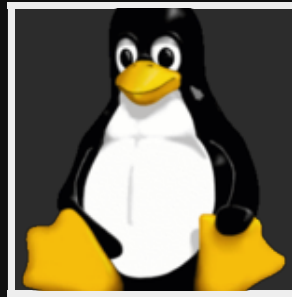

Cyklo{koalícia,kuchyna}

Offering space for their agenda, making
Bratislava cycle-friendly++



OWASP

owasp testing guide



Educative Workshops

**come to learn something new
for you**

Infinity mirror workshop



TravelHacking

We made collaborative document with more than 20 contributors how to travel cheap, evade jetlags and book expensive hotels for a buck

Arduino hacking

Rorschach test workshop



Rorschach test workshop#2



Soldering workshop w/ Mitch Altman #1



Soldering workshop w/ Mitch Altman #2

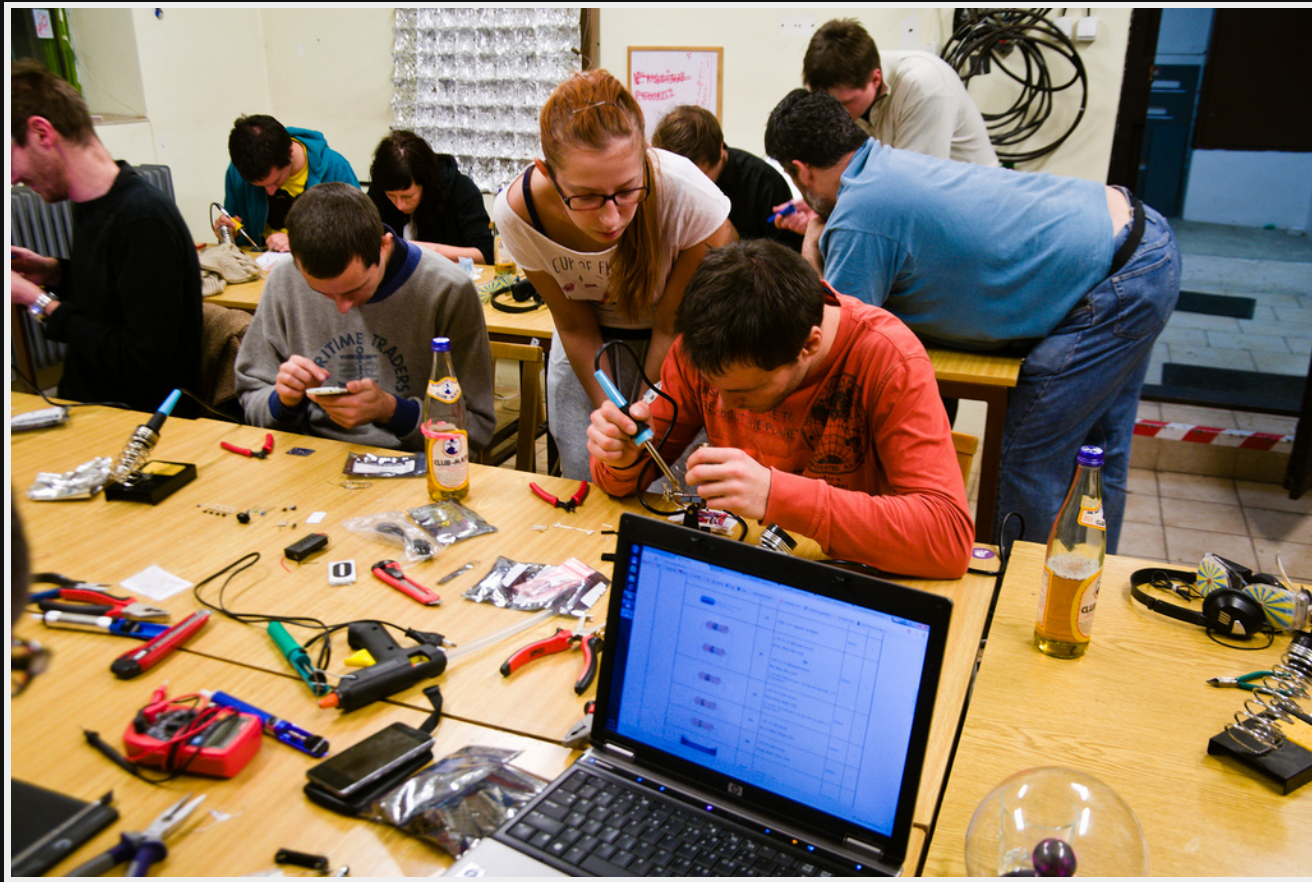

Notebook cleaning



We love open-platform games



Freemap.sk hacking



Chill = _ =



meet wordpress ^ _ ^

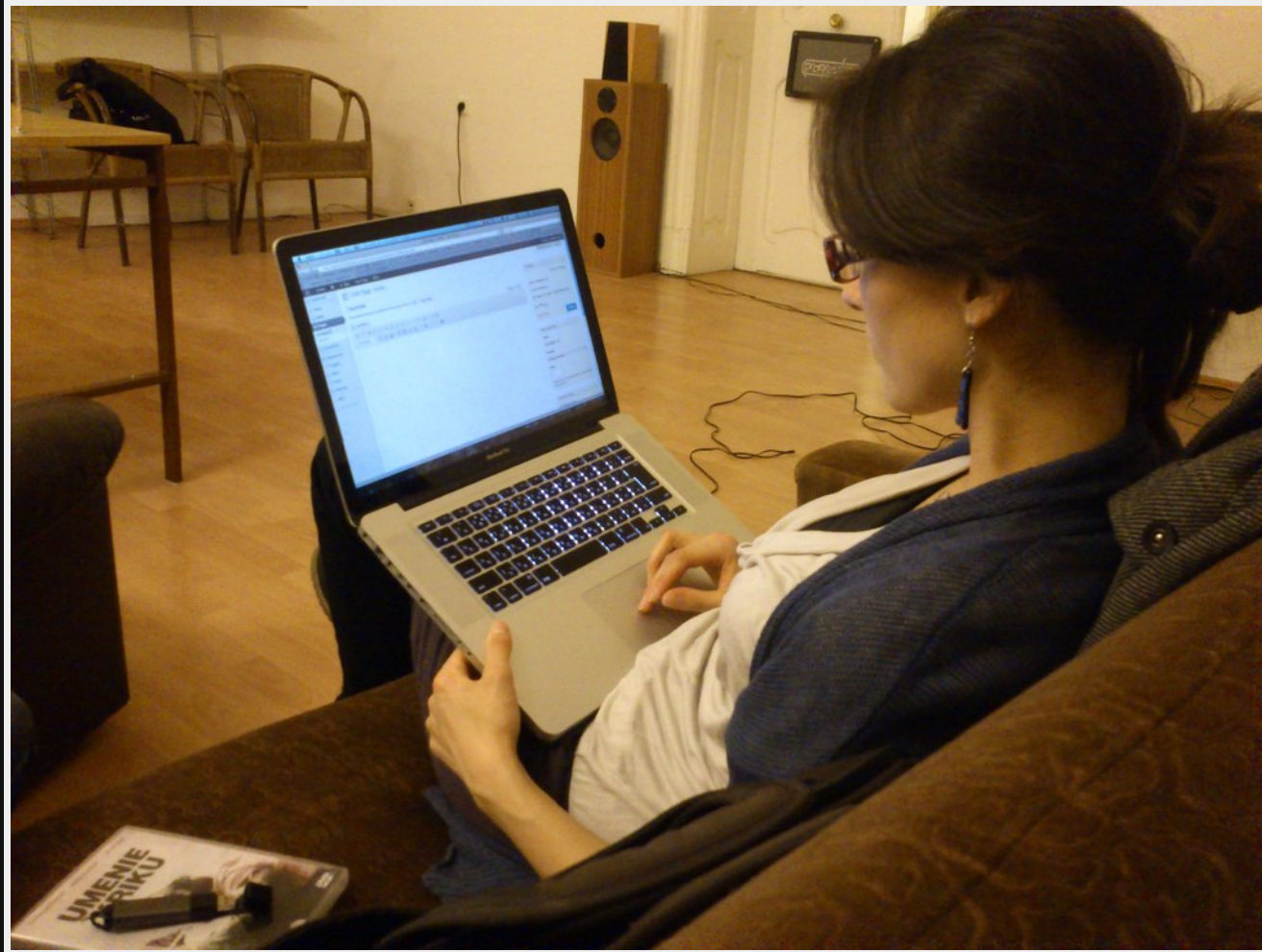

Obcan K - pre-screening



Obcan K - w/ discussion



**We have now reliable kitchen
for ..**



Learning DNSSEC and DANE



Cyklokoalicia meet-up



Critic of cryptocurrencies



Making of Bitcointhedocumentary.org



Join us!

We have cookies.

- <http://brmlab.cz/> | #brmlab
- <http://base48.cz/> | #base48
- <http://progressbar.sk/> | #progressbar
- <http://v01d.sk/> | #v01d